

# FREIGHT CARS

• HISTORY • MODELING • NEWS

JOURNAL

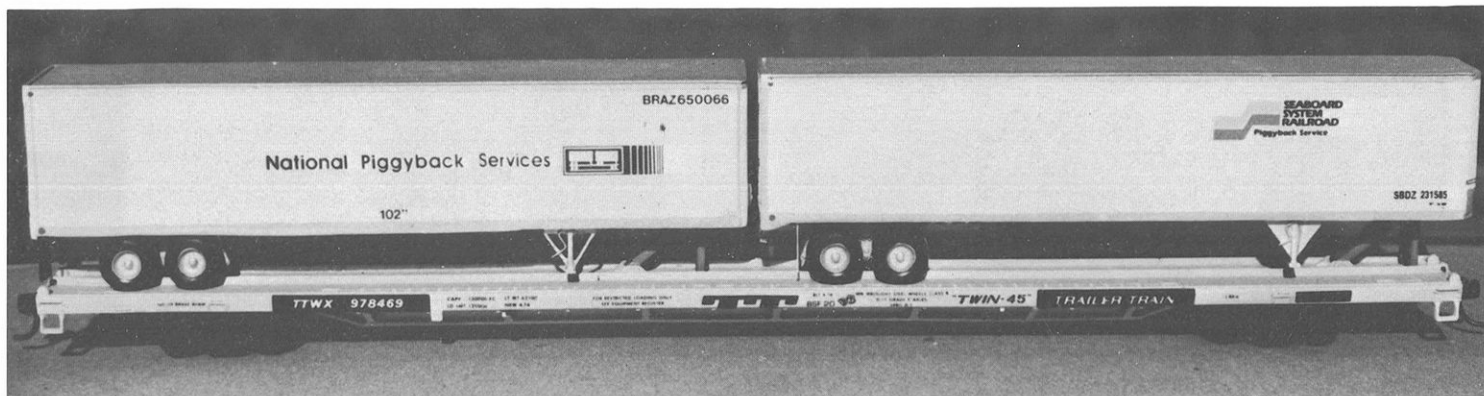

89'4" Piggyback Flats from Athearn Parts

Texas & Pacific Series 74008-74062  
50-ton Boxcars

Modeling Two Modern Southern  
40-foot Boxcars in HO Scale

APRIL 1986

\$3.00

FREIGHT CARS JOURNAL

Vol.3 #3

April 15, 1986

Issue 15/16

Editors

David G. Casdorff  
Eric A. Neubauer

Associate Editors

Jim Eager  
Pat Holden  
Al Tuner  
Richard Yaremko

Copyright ©1986 SFCH

ISSN 0742-9355  
All Right Reserved

\$15.00 USA/Canada  
\$20.00 All Others (Surface)  
\$30.00 All Others (Airmail)  
U.S. Dollar Funds Only

Please make checks payable to either  
Freight Cars Journal or the Society of  
Freight Car Historians.

Dues/ Subscription - sent to:

David G. Casdorff  
P.O. Box 1458  
Monrovia, CA 91016

Published by:

Society of Freight Car Historians

CONTENTS

Features

Texas & Pacific Series 74008-  
74062 50-ton Boxcars  
*William B. Kelly*.....3

Modeling Two Modern Southern  
40-foot Boxcars in H.O. Scale  
*Staffan Ehnbo*.....4

89'4" Piggyback Flats from  
Athearn Parts  
*Gary A. Smith*.....9

The New York Central's 1916  
All-Steel Box Car Project  
*Richard Burg*.....11

Columns

Class 1 & 2 Railroad News.....2  
Shortline News.....15  
Private Owners & Lessees News.....15

-Cover Photos-

*TTWX 978469, an HO scale model built from Athearn Parts (see article on page 9). The Brae (1.) and Trailmobile (r.) 45' trailers were also built from Athearn kits. Model by Gary A. Smith.*

*Michigan Central 99999 represents one of the Central's first all-steel boxcars to be built in large numbers. This Lot (#324B) was the only group to receive end doors. See article on page 11.*

*Richard Burg Collection*

CLASS 1 & 2  
RAILROAD NEWS

**Atchison, Topeka & Santa Fe** - It appears as though the Santa Fe has finished rebuilding the FT-108 piggyback flat conversions in series 299599-299682. A number of cars have been sighted with 12-85 and 1-86 shop/rebuild dates on them. An interesting note - some of these are being painted in a new (for Santa Fe pig flats of recent years) livery of boxcar red (brown) and white lettering. Can't confirm a correlation, but those sighted as rebuilt in '85 were painted white with black lettering, while those sighted rebuilt in '86 have the new brown with white lettering. -David G. Casdorff

**Chessie System/ B&O** is on the move again with new purchases of auto racks mounted on Trailer Train flats. So far, I've seen some bi-levels with 1-86 new built dates (on auto racks only). More on these later. -Carl W. Shaver

**Chicago, Central & Pacific**, America's newest Class I (?) has and probably will be acquiring quite a few freight cars. The first of these to be reported to FCJ are some ex-NAHX Pullman-Standard built 4750 cube covered hoppers from the 479000 series (sighted CC 481194, 481819, and 481869). Reporting marks for this road is "CC". -Carl W. Shaver

**Chicago and Northwestern** has been very active in acquiring a variety of used cars including gondolas, covered hoppers, RBL-reefers and piggyback flats.

Series 130300-130359, a group of bright red USEX built, 100 ton, 52'6" gondolas were recently acquired from a presently unknown source.

Another group of gondolas, CNW series 340000-340099 built by SIECO 4-5-81 were recently acquired from the Browns-ville and Rio Grande International Railroad's series BRG 40206-40594 (100 cars).

The CNW has also acquired some second-hand Canadian built covered hoppers (as the Seaboard recently did) in the CNW series 460071-460444. These are 50'6", 100-ton cars built by Marine Industries and acquired from Rex Leasing (RRRX).

Also coming from Rex Leasing is series CNW 463001-463024, from RRRX 2001-2150. These are 53'6" 4700 cube covered hoppers built by FMC in 1980.

Next, the CNW has received a number of RBL-reefers that were previously Roscoe, Snyder and Pacific. CNW numbers start at 540000 and so far go as high as 540039. These are 50'6" cars and have various build dates.

And the CNW has joined the single van piggyback club. CNW 780000, a 50'9" piggyback flat was formerly Fruit Growers Express (FGER) number 1000. But, the CNW hasn't stopped there. In what appears to be a whole new series are some converted single-van piggyback flats numbered CNW 780501 and 780502 (sighted so far). They are gray cars with black lettering and red "XTRA" logos. Apparently, MKT's Denison Shops are doing the conversions (?). Conversion dates on these two cars were 2-86. -Carl W. Shaver

Conrail has purchased some new built auto racks mounted on Trailer Train flats. Included is a group of bi-levels

built by Greenville (first racks I've seen built by them) of a Portec design. These are Conrail class ML2D and numbered in the CR 1500's (1541, 1543 sighted). New build dates for the racks is 12-85.

In addition, Conrail has acquired a number of tri-level auto racks mounted on ETTX prefixed Trailer Train flat cars. These are Conrail class ML3D and were built by Thrall Car in 11-85. Numbers in the CR 3300's (3330 through 3375 sighted so far). -David G. Casdorff

**Grand Trunk Western** has been active in new and rebuilt intermodal cars this past year.

First off were a series of 21 single-van piggyback rebuilds. These 56'1" flat cars were originally from the series GTW 616775-616874 built in 1964 as general service flat cars. Twenty-one of these cars were converted in 6-85 by the GTW and numbered GTW 350000-350020. The cars are GTW blue with orange Trinity hitches (like those on the TTUX cars) and white lettering.

In late 1985, the Grand Trunk began placing in service a number of new auto racks mounted on Trailer Train flats. Unlike the previous new rack orders mounted on Trailer Train cars, these were painted GTW blue (previous ones were "yellow"). This order included a number of bi-levels built by Thrall Car in 11-85 and a number of Tri-levels with dates of 12-85 and 1-86 reported so far. The later, tri-levels are Thrall Job 877. Also this is the first order of auto racks that the GTW has painted the rack numbers on the rack (previous order was stamped only). -David G. Casdorff / Carl W. Shaver

**Illinois Central Gulf** placed in service a number of piggyback vans, most leased from XTRA and built during 1985.

ICGZ 235000-235199 were built (some rebuilt) by Miller. These have the "XTRA trim" livery and are 45' long by 102" wide trailers with horizontal rails at the rear for load securement.

A group of 100 semi-insulated vans were built by Dunham and numbered ICGZ 735000-735099. These too have "XTRA trim" and are 45' x 102" vans. This group has horizontal rails at both the nose and rear of the vans.

Lastly, a series of 100 48-foot by 102" wedge vans were placed in service on the ICG last year. Numbers are ICGZ 815000-815099. These also have horizontal rails in the nose and at the rear of the vans. For purposes of comparison these vans have 3562 cubic feet of cargo space. Presently this design (wedge design) and length are the maximum cubic capacity van used by any railroad or leasing company in piggyback service. Compare the 3562 cubic feet to the ICGZ 235000 series mentioned above of 3202 cubic feet. -David G. Casdorff

**The Milwaukee Road** acquired a number of 100-ton, two-bay covered hoppers in 1984 that were not previously reported in FREIGHT CARS JOURNAL. This is the group of 97 cars in the series MILW 96000-96096 built by Portec in Winder, GA in 6-84. These are 35' inside length, 3000 cubic foot cars. -David G. Casdorff

Continued on Page 15

# Texas & Pacific Series 74008-74062

## 50-ton Boxcars

William B. Kelly

This series of boxcars was built in August 1929 by American Car & Foundry at St. Louis, Mo. as series 70500-70749 AAR class XM. Originally they were of wood-en single sheathed construction and had two six-foot Youngstown sliding doors on each side with staggered openings.

In 1950 and 1951, T&P's Marshall shop converted these 55 cars to XAP's by replacing the wood in the sides with .10" steel plate, lining the interior with 3/4" plywood on the sides and 13/16" tongue and groove pine on the ends, installing Evans type "DF" utility loaders, reducing the door opening from 12' to 8' and installing six-panel Superior doors (the

original opening extended to the left of the new door). The strengthening plate along the side sill was added later, sometime between May 1957 and October 1960. Numbers 74008-74032 had steel floor plates between the door opening while numbers 74033-74062 received nailable steel flooring and Apex metal running boards. Numbers 74008-74032 and 74053-74062 were equipped with eight belt rails and 74033-74052 had 19 belt rails installed. All cars had the original radial flexible steel roof and three section inverted Dreadnaught ends. Westinghouse "AB" brakes and Ajax hand brakes were applied to all cars. Cars

were later changed to AAR XME, XML and XL in later years.

These cars wore a utilitarian boxcar red paint scheme lettered in white. "Texas & Pacific" was spelled out on the left end with large initials, numbers and bars underneath. There was no herald on the right end as T&P seemed to apply these only to double sheathed cars, however I have no documentation to that effect. Later repaintings dropped the bars and adopted a smaller set of initials and numbers.

By January 1972, only two cars remained on the T&P roster.

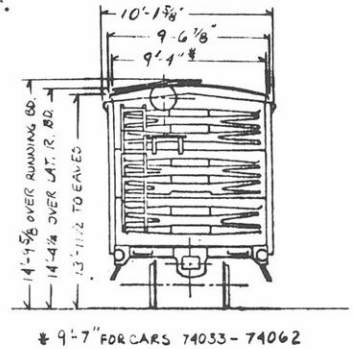
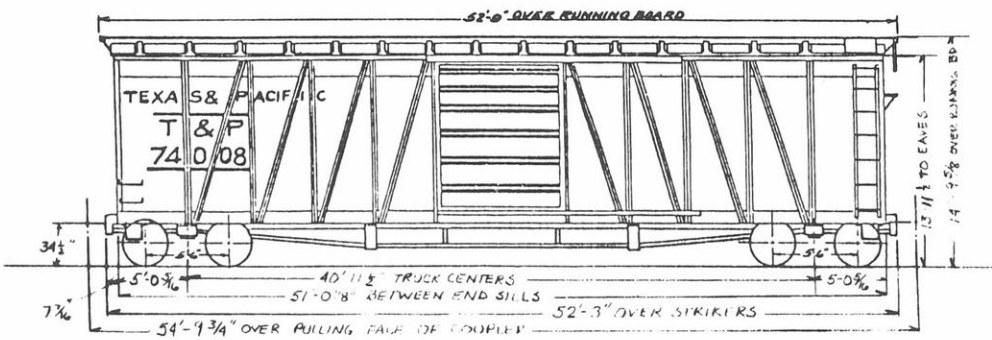

Texas & Pacific 74037 shown here circa mid-1960s. Photographer, date and location unknown (Collection of William B. Kelly).



# Modeling Two Modern Southern 40-foot Boxcars in HO Scale

## Staffan Ehnbon

©1986 Staffan Ehnbon

A little information and a nice 3/4 angle picture is all it takes to inspire a freight car modelling project. But at times the 3/4 picture is not entirely satisfactory. This is the case with the picture of SOUTHERN box car number 508783 on p.36 of the FREIGHT CARS JOURNAL no. 4. It shows the ends, sides and doors well enough, but the roof panels don't show. The modelling project was too good to give up that easily so calls for help went out to Dave Casdorff and Red Davis. Red came up with a photo of Southern 508392 (see photo) that was similar to our inspiration, but had a wider door, a different side sill and details and a Pullman type of roof. This style was easier to model and was chosen for a starter. But when Dave came up with a broadside picture of the 508783 showing it to have a diagonal panel roof the challenge became too much to resist. So after the easy model no. 508264 was built, the slightly more difficult kitbash for no. 508742 was made.

### EASY 508264

Any 40' PS-1 box (AHM, CCS etc.) can be used as a starter. The 508264 started out as an AHM car. The running board is removed. The mounting holes in the roof are filled with putty and filed to conform with roof panel profile. Ladders are removed and mounting holes filled with putty and smoothed. End brake gear and grabs are chiselled off and the ends sanded smooth. The side sills and sill steps are completely removed as are door guides. The door stops at the end of the top door guides are chiseled off and saved. The door opening is widened to 10 feet. The depression behind the top door guide is filled with strip styrene.

Two scale 34' lengths of .040 thick styrene, 12 scale inches wide are shaped as in fig.1 for the side sills. They are drilled for the roping eyes at both ends then cemented to the bottom of the sides.

An Athearn Railbox type of door (part no, 55201) is located over the door opening. An Evergreen scale 2"x2" strip of styrene, a scale 21'6" long is cemented to the top of the side just above the door as part of the top door guide. A 1"x3" styrene strip is

then cemented to the outer face of the 2"x2" with about an inch extending down to retain the top lip of the door. Beware that the door is not cemented to the guide, if you want the door to be operational.

A 2"x2" styrene strip is cemented to the rear of the bottom face of the door as a retaining lip. Then the bottom door guide is built up from one 2"x3" strip with its 2" face cemented to the side sill just below the door lip. A 1"x3" strip is cemented to the outer face of the 2"x3" extending upwards to retain the bottom lip of the door. The bottom door guide is 19'6". The door stops saved are cemented to the sides near the end of the bottom door guide. A length of .010 plastic rodding (Grandt Line no. 3901) or brass wire is bent into a "U" shape and cemented into the two holes drilled into the side sill ends for the roping eyes.

New side and end ladders are built up from 2"x2" styrene strip risers and .010 plastic rodding grabs. The side ladders are mounted on small blocks of 1"x2" styrene strips to space the risers from the car sides. The grabs at the left of the sides are Detail Associates bracket grabs no. FC6209. They are also used for the grab on the end just below the tack board. The grab at the bottom of the right side of the end is built up from a length of .010 brass wire bent to shape and inserted through holes in two pieces of 1"x2" strip styrene cemented to the end at the bottom edge.

The long grab across the end is a scale 8' long length of .010 brass wire. It is cemented with ACC to a bracket at the right side of the end. This bracket is bent into shape from a scale 2" wide strip of thin brass cut from a sheet with a scalpel. The left end of the grab is cemented with ACC to the face of the right end ladder riser. Near the center of the grab an eye pin made from twisting a very thin wire around the grab is anchored into a hole in the end.

A CalScale brake wheel and gear box is cemented to the end. A brake step is made from a scale 24"x9" piece of roof running board. This model uses

plastic running board material thinned by scraping the underside. A notch is made for the brake chain. Support brackets are made from 2"x1" strips.

Sill steps are shaped from scale 2" wide strips of thin brass. A jig as described on p. 37 of the September 1985 MAINLINE MODELER magazine facilitates sill step production considerably. Check prototype photo for step shape in each case. The sill steps are cemented to the bottom face of the side.

The AHM floor was used. But the truck spacing is a little too close. On the model it was moved to 31'6" spacing, which however seems a little too long. 30'10" may be correct. New King pins were made from surplus Kadee coupler pocket parts and styrene blocks drilled for the truck screws. Athearn twin coil, roller bearing trucks were used. Kadee no. 5 couplers were screwed to the floor.

The car including underbody and trucks is painted Accupaint rich oxide brown over a coat of Accupaint stencil white. Then the roof is sprayed with a 50/50 mixture of Floquil silver and reefer gray to represent galvanized iron.

Microscale lettering set no. 14 provided slogans, numbers and the road name. Like the prototype the road name starts all the way out on the side flange of the end. The Microscale road name still had to be cut in pieces to squeeze the name together to fit between car end and door opening. The "GIVES A GREEN LIGHT TO INNOVATION" was subjected to this procedure too. All data is from Herald King set no. D-2. The consolidated stencils are from Champ set no. HD-31.

### MORE DIFFICULT 508742

The mixture of Pullman details but a diagonal panel roof was too much to resist. It had to be modeled. A readily available 40' car with a diagonal panel roof is the Athearn grain-loading box no. 2090-2096. Chisel off all major side detail protrusions from the body and sand the sides smooth. Cut out 9' wide and 9'8" high door



Prototype car no. 508392 is the prototype for the easy model. The car has typical Pullman details including the roof panels. The door seems to be a later addition.  
(Red Davis photo)



Model car no. 508264 is an AHM car with an Athearn Railbox door and a new side sill and details (Staffan Ehnбом photo)

openings in the sides. Cut off the ends. The CCS Pullman ends we are going to use are wider than the Athearn ends. We can therefore add styrene sheet overlays to the sides. A strip of 2"x4" styrene is cemented along the top of the sides as the car line. Four 15'6" x 9'8" pieces of .020 styrene sheet are scored to represent the welded sides and cemented in place. Another 2"x4" strip is cemented to the car sides below the side overlays. Three pieces of .020 styrene sheet are cut out as in Fig. 2 and cemented to the Athearn side sill. All parts of the Athearn side sill not covered with the new side sill overlays are removed.

The bottom corners of the door opening are reinforced with plates. These were cut from .010 styrene and cemented in place. After the cement has completely dried the plates were sanded.

The CCS Pullman end castings are fitted and cemented in place. Cracks are filled with putty and the ends are then filed to conform with the car body.

Athearn Railbox type doors are 10'3" wide. We need 9'3" wide doors. Therefore a scale 6" strip is removed from just inside each of the side frames of the Athearn door. The side frames are then cemented to the remaining centerpiece of the door. A 2"x2" styrene strip is cemented to the rear of the bottom face of the door as a door guide retaining lip. Then the doors and door guides are fitted as for the previously described car.

The bottom of the sides just outside the bolsters are drilled for the roping eyes made from styrene rod. Ladders are built up and Detail Associate bracket grabs are attached to the sides. The bracket crab on the end can be modelled with two 1"x2" strips of styrene as the brackets between two end bulges. A length of .010 styrene rod is cemented to the brackets as the crab. The crab at the bottom of the end is .010 brass wire inserted into holes drilled into the end near

the bottom. The crab across the end is simpler than on the other car. A .010 brass wire is bent at the ends and secured in holes drilled into the ends. An eye pin is made for a center support. End brake gear is built up as for the earlier car. The two different types of sill steps were formed in jigs and cemented to the bottom face of the sides. This car also received coupler release rods. The Athearn car weight, floor and underframe were used with a Cal Scale brake set. The brake cylinder, reservoir and AB valve are mounted closer towards the "A" end of the car than is usual (See photo of prototype car 508783). Athearn twin coil roller bearing trucks were used.

The car was painted like 508264. Car numbers, road names and slogans again came from Microscale set #14. Capacity data is from Walthers # XD-637. Dimensional data is from D-635. Consolidated stencils from Champ HD-31.

#### MATERIALS LIST

| Description and Part Number                       | 508264                | 508742 |
|---|-----------------------|--------|
| AHM (or other) PS-1 40' box car                   | 1                     |        |
| Athearn grainloading box car no. 2090-2096        |                       | 1      |
| Athearn Railbox doors part no. 55201              | 1 pr                  | 1 pr   |
| Athearn or other twin coil roller bearing trucks  | 1 pr                  | 1 pr   |
| Cannonball Car Shops (CCS) box car ends 197J30008 |                       | 1 pr   |
| Calscale AB brake set no. 283                     | 1                     | 1      |
| Detail Associates bracket grabs no. FC 6209       | 6                     | 4      |
| .010 sheet styrene                                |                       | 1      |
| .020 " "  |                       | 1      |
| .040 " "  | 1                     |        |
| Evergreen scale 1"x2" strip styrene no. 8102      | 1                     | 1      |
| " " 1"x3" " " 8103                                | 1                     | 1      |
| " " 2"x2" " " 8202                                | 1                     | 1      |
| " " 2"x3" " " 8203                                | 1                     | 1      |
| " " 2"x4" " " 8204                                |                       | 1      |
| .010 Grandt Line plastic rodding 3901             | 1                     | 1      |
| .010 brass wire                                   | 1                     | 1      |
| thin sheet brass                                  | 1                     | 1      |
| Accupaint stencil white no.1                      | 1                     | 1      |
| " Rich Oxide Brown no. 54                         | 1                     | 1      |
| Floquil bright Silver no. 110101                  | 1                     | 1      |
| " reefer gray no. 110012                          | 1                     | 1      |
| Microscale decal set no. 14                       | One set for both cars |        |
| Champ consolidated stencil set no. HD-31          | " " " " "             |        |
| Herald King set no. D-2                           | 1                     |        |
| Walthers data set no. XD-637                      |                       | 1      |
| " " " no. D-635                                   |                       | 1      |

#### Previous articles in FCJ's "The 40-foot Boxcar in North America" series include:

|  |                      |                               |
|--|----------------------|-------------------------------|
| "Modeling GN 40-foot Boxcars"  | by Staffan Ehnbon    | FCJ 1:4 pp 4-8, June 1984     |
| "New and Rebuilt 40' Boxcars of the 70's and 80's"   | by David G. Casdorff | FCJ 1:4 pp 15-16, June 1984   |
| "FCJ's 1985 Forty-foot Boxcar Survey"  |                      | FCJ 2:3 pp 5, February 1985   |
| "Comments on Ehnbon's Great Northern 40-foot Boxcars Article"                                | Cyril Durrenberger   | FCJ 2:5 pp 8, April 1985      |
| "A Reply to Durrenberger"  | Staffan Ehnbon       | FCJ 2:5 pp 8, April 1985      |
| "Modeling The Southern Pacific 605550-605699 Modern Forty-foot 100-ton boxcar in H.O. Scale" | Staffan Ehnbon       | FCJ 2:6 pp 5-6, July 1985     |
| "Modeling Monon Boxcar No. 1"  | Staffan Ehnbon       | FCJ 3:2 pp 9-10, January 1986 |

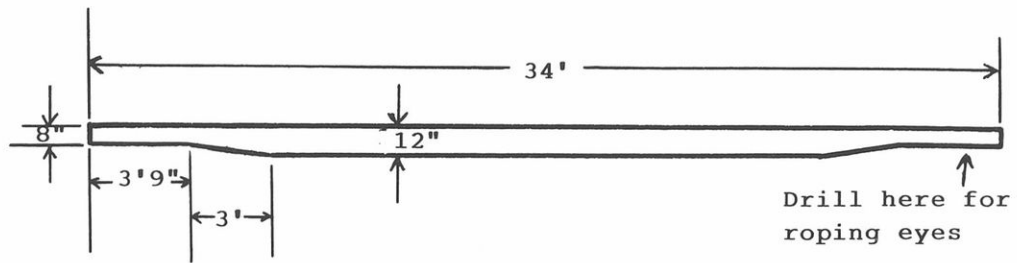

Fig. 1 - Side sill for car no. 508264. All measurements are estimations from photo.

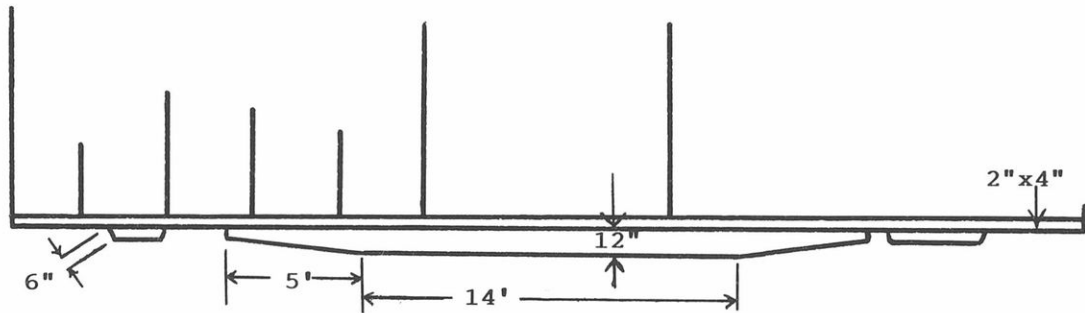

Fig. 2 - Side sill and side weld seam location for car no. 508742.

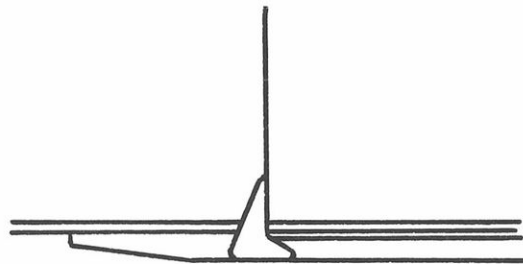

Fig. 3 - Reinforcement plates at door, 508742





*This broadside shot of prototype car no. 508783 faintly shows the roof panels to be of the diagonal type. (David Casdorff photo)*



*Model car no. 508742 is built up over an Athearn grainloading box car body with diagonal roof panels, side overlays scribed to represent welded construction, narrowed Athearn doors and CCS Pullman type ends (Staffan Ehnbohm photo)*



# 89'4" Piggyback Flats from Athearn Parts

## Gary A. Smith

### INTRODUCTION

Even with the explosion of new intermodal car designs in recent years, the backbone of the railroads' intermodal fleet remains, and will remain well into the 1990's, the 89'4" flush-deck flat-car.

Unfortunately for modellers, no such car has been produced in kit form. Athearn makes an 85' flush-deck FC (their "All-purpose" flatcar), but to my knowledge, no prototype for the model exists, it probably having been made 85' long to use as much existing tooling as possible.

This doesn't mean that we have to do without 89-footers. Using the method I am about to describe, any modeller with basic tools and skills can produce reasonably accurate cars from the Athearn kit.

### MATERIALS

- 2 Athearn #2015 "all-purpose" flatcars.
- Body Putty
- .020 Styrene (not needed for static models)

### TOOLS

- Scale Rule
- Hobby Saw
- Hobby Knife with #11 and #17 blades
- Miter Box
- Dremel Tool or Hacksaw or large Ten Snips
- 1" C-Clamps (2)
- Small flat file

### PROCEDURE

1- Take the bodies of the 2 cars and measure off 44'9" from the "A" end of the car and the same distance of the "B" end of the other. Cut the two bodies along the lines you measured.

2- Take the small file and clean up the saw cuts. Slightly bevel the edges of the cuts on the bottom of the body.

3- Butt the halves together and flow liquid cement into the joint. When doing this, it is best to clamp the car to a flat surface and against a straightedge. (I do this by turning an Xacto #7533 miter box upside-down and using the bottom as a surface plate and the lip on the bottom as the straightedge. Place the two

halves together upside-down on the surface plate and clamp them down, then flow the cement into the joint.) Allow the glue joint to dry overnight.

4- Cut the car weight. The location of the cut is not critical as long as it is made inside the screw boss holes in the weight. It is best to stagger all of the joints in the car to provide structural strength. Cut the second weight to fill the remaining space. Some of the mounting lugs underneath the body may have to be removed. (A Dremel tool with a cutoff wheel is the best way to do this, but a hacksaw or snips are just as good.)

5- Glue the weight sections into the body with cyanoacrylate. When installing the weights, place them so that the slight curve in the weights will put a "crown" in the car deck like the prototype.

6- Placing the "B" end to the right, cut one underframe at the first crossmember to the left of the air reservoir. Attach the section to the car body with Cyanoacrylate. Cut a section from the second underframe to fill the remainder of the floor and glue in.

7- Cut the lower frame of the car to remove one slanted section. Glue the cut lower frame to the underframe. Cut the second lower frame to fill the remaining room under the car.

8- Putty any gaps in the deck. If you are planning to make a "Twin-45" car, use a #17 blade to carefully carve the hitch bases off of the car and save them for future use. Putty any holes for the hitches if you are doing this version. Set the car aside for a few days for the putty to dry.

9- Sand the puttied areas on the car. If you are building an operating model, also sand the area of the underframe where the drawbar swings in order to remove any flash or mold marks. **THIS IS CRITICAL** on an operating model so the drawbars can swing freely and car track properly through curves.

10- Before painting the car, the body should be sprayed with Barrier or Glosscote to protect the putty from the paint. If you are building an operating model, mask off the drawbar areas before painting.

11- Once the car is painted, a static model can be completed by attaching the remaining parts as per Athearn's instructions.

12- For an operating car, the drawbars and bolsters must be modified. First, the drawbars: The rounded portions of the drawbar must be cut off and the top of the drawbar sanded smooth. Place the drawbar onto the underframe. Save the removed parts of the drawbar. Modify the bolsters by cutting off the long portion of the bolster. Discard the removed part of the bolster. Attach the bolster to the underframe.

It will be necessary to make a retainer to prevent the drawbar from sagging. The retainer is made by gluing the round portions removed from the drawbar to the underframe just inside of the steps. They should be placed so as to allow the drawbar to swing the full width of the car. The two "L" shaped pieces should be removed from the drawbar remains. Finally, a piece of .020 Styrene should be glued across the stops to prevent the drawbar from sagging.

13- Finishing the "Twin-45" car: Assemble the hitches per Athearn's instructions, then glue the hitch bases removed in step #9 to the bottom of the angle support. The hitches should be custom fitted to each car. First, mark the center of the car. Place the hitch under the trailer that you plan to use. Place the trailer so that its rear is just ahead of the centerline. The hitch should then be glued in place where it sits. Repeat the procedure with the front of the second trailer to set the rear hitch.

(see drawings on next page)

# 89'4" FLATCARS FROM ATHEARN PARTS

## Body Cuts-

### Body #1

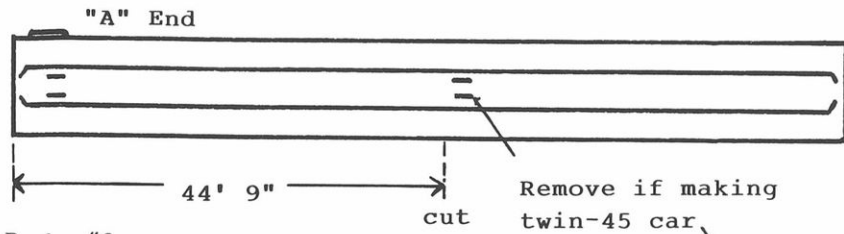

### Body #2

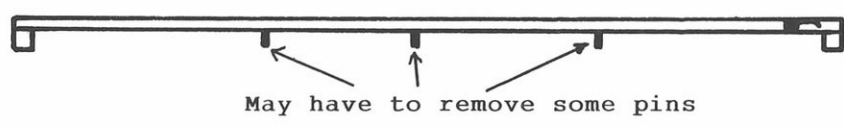
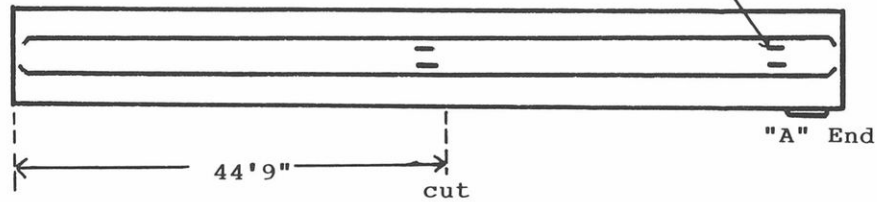

## Underframe-

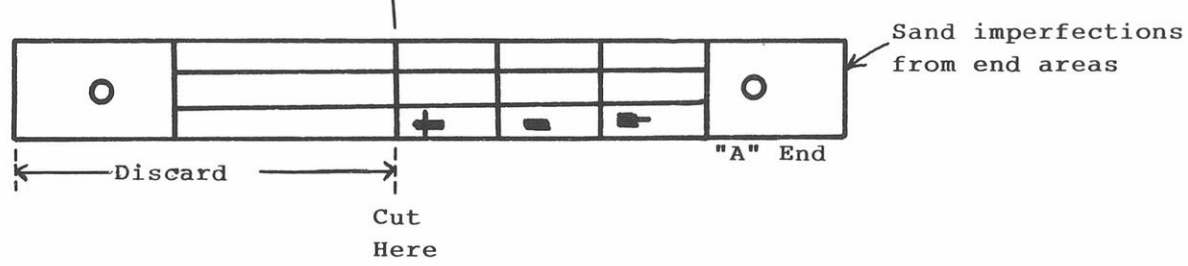

Cut balance from 2nd underframe

## Drawbar & Bolster

### Bolster

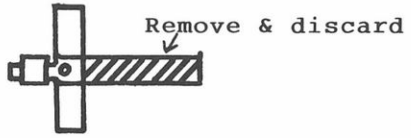

### Drawbar

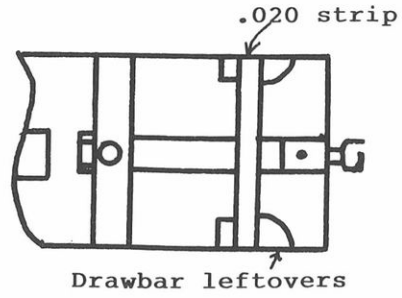

Gary A. Smith  
1-21-86

# THE NEW YORK CENTRAL'S 1916 ALL-STEEL BOX CAR PROJECT by Richard Burg

When the Pennsylvania Railroad produced its first X25 all steel box car in 1913 they couldn't lay sole claim to a new innovation. Several other experiments with all steel box cars had preceded the X25, but by 1915 when hundreds of X25 box cars, and X25A auto box cars were rolling off assembly lines the PRR could state that they were the first road to do more than dabble with steel house cars.

Meanwhile the arch rival New York Central could claim an all steel box car in 1912 (Car #91124, built by ACF in Detroit; see the 1919 Car Builder's Dictionary p. 250), and although they did not put the design into production, they were serious about adopting the new technology.

Beginning in January of 1916 the delivery of large numbers of all steel auto box cars began on the NYC subsidiary the Michigan Central Railroad. This was close on the heels of the PRR's massive X25/X25A orders of 1915, and could be viewed not so much as a copying of the PRR, but rather a working along similar lines. In fact the same builder, Haskel & Barker of Michigan City, Indiana, built the MCRR auto box car order soon after finishing a large PRR X25A order. These Michigan Central cars, lot number 324B, number series 99500-99999 were truly the Central System's head to head competition for the Pennsy's X25A. Several other

lots also built in 1916 closely followed the Lot 324B design only lacking the end doors.

Characteristically the NYC designs called for smaller dimensions. Compared to the PRR X25A, the Lot 324B was approximately 2" shorter, and 5" narrower inside, which resulted in a reduction of almost 250 cubic feet of load space, but beyond this slight holdback to earlier times the Michigan Central design looked fairly advanced. The PRR X25/X25A design required elaborate side sheet pressings which were flanged inward at the top and bottom, plus had their "hat sections" at each seam pressed integral into the wall section. The Lot 324B and related lots had the more normal riveted side sheet design. In fact the lack of double rivet lines would indicate that something other than hat sections were used to join each seam which would place the cars well ahead of their time.

Lot 324B was the only group of cars in this general design to have end doors. Those doors appear to be similar to what on a closed end car would be termed a "Vulcan end."

As with most early steel designs the fast advances in steel car technology were to render the initial cars rather primitive. The odd end doors seemed to be a problem. By as early as 1929 sixteen of the cars had the end doors

"permanently closed". The roof was an internal carline "outside metal" roof. Such a design robbed the car of about 2" of inside head room which later all steel roofs could provide. By 1935, two cars in Lot 324B had been rebuilt with the all steel roofs. This raised their cubic capacity from 2984 cu.ft. to 3070 cu.ft.

In the early 1940's a massive effort was undertaken to upgrade all the Lot 324B auto box cars. In addition to new roofs, the ancient end doors were replaced with modern Dreadnaught end doors which reverted the "permanently closed" cars to being functional end door cars. The rebuilt cars were renumbered into the NYC 143500-143999 series.

In the post World War II era most pre-WW I steel designs suffered large scale retirements. The Lot 324B auto box cars were no exception. By 1956 only 58 of the 500 cars were still in service, and all of the cars were gone by the early 1960's.

*Below: PRR 538598 - The competition, Pennsy's X25A. H&B produced 1000 in 1915 and the PRR's Altoona Shops another 1000 in 1916/17. Note the doors staggered to the right, later classes would be staggered to the left.*

Richard Burg Collection

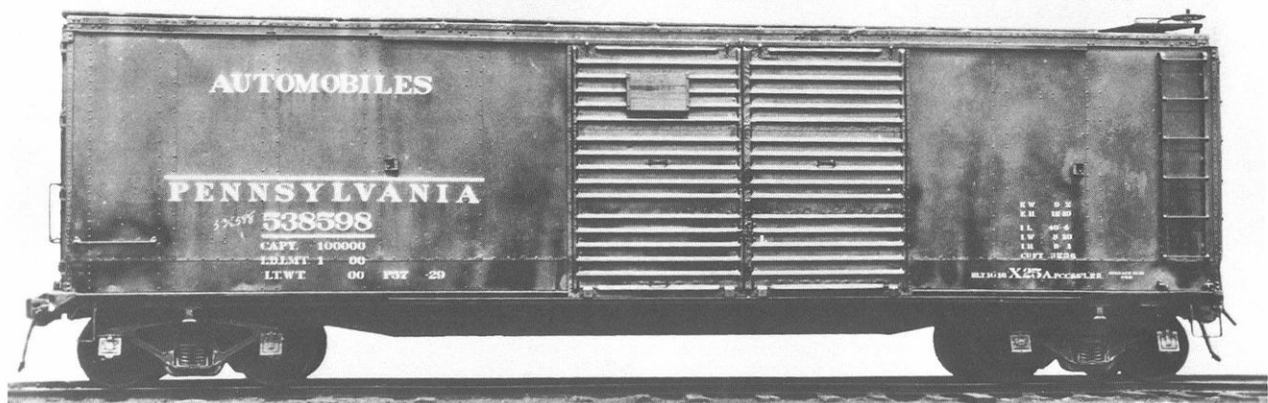



Michigan Central 99999: These cars (Lot 324B) were the earliest ones produced in the NYC's 1916 all-steel box car project. They also were the only ones to have end doors. Seven other lots were produced in 1916 without the end doors, but otherwise built along the lines of these Michigan Central cars. The photo above shows a 3/4 view of from the "B" end of the car. On the right is the "A" end with doors.

Richard Burg Collection

STENCILED DIMENSIONS

- Hgt at Eaves 12 ft 8 in
- Wth at Eaves 9 ft 0 in
- Lgt Inside 40 ft 6 in
- Wth Inside 8 ft 6 in
- Hgt Inside 8 ft 8 in

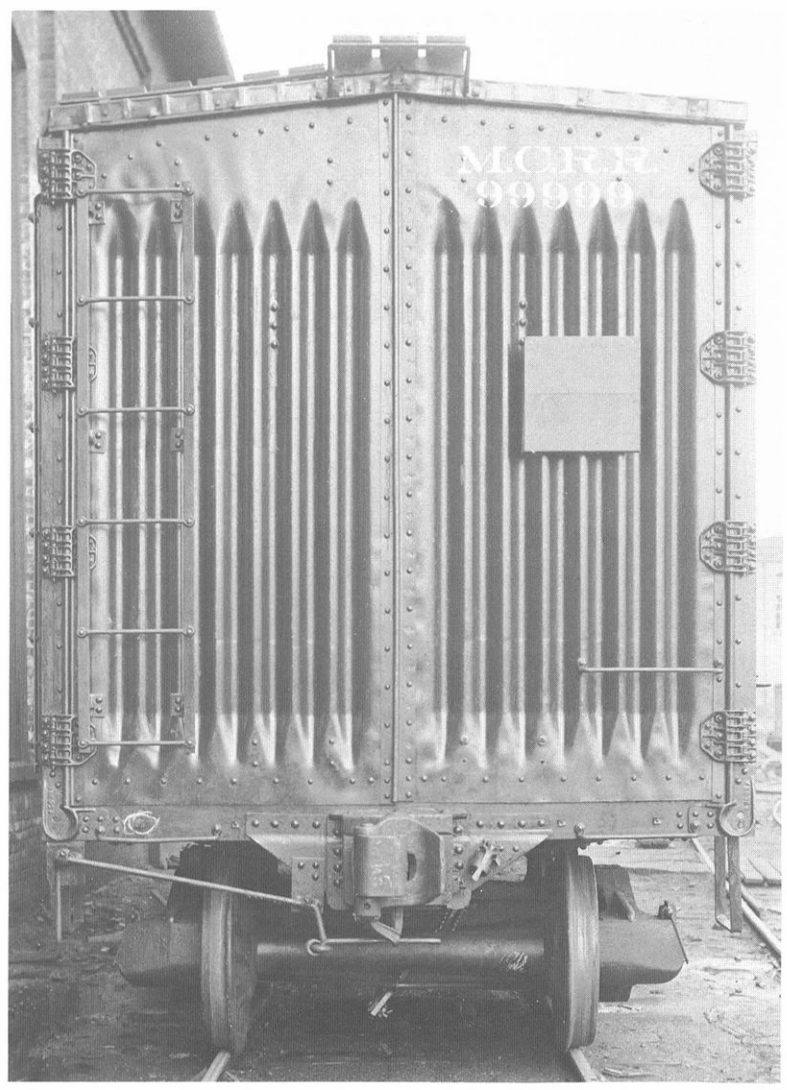



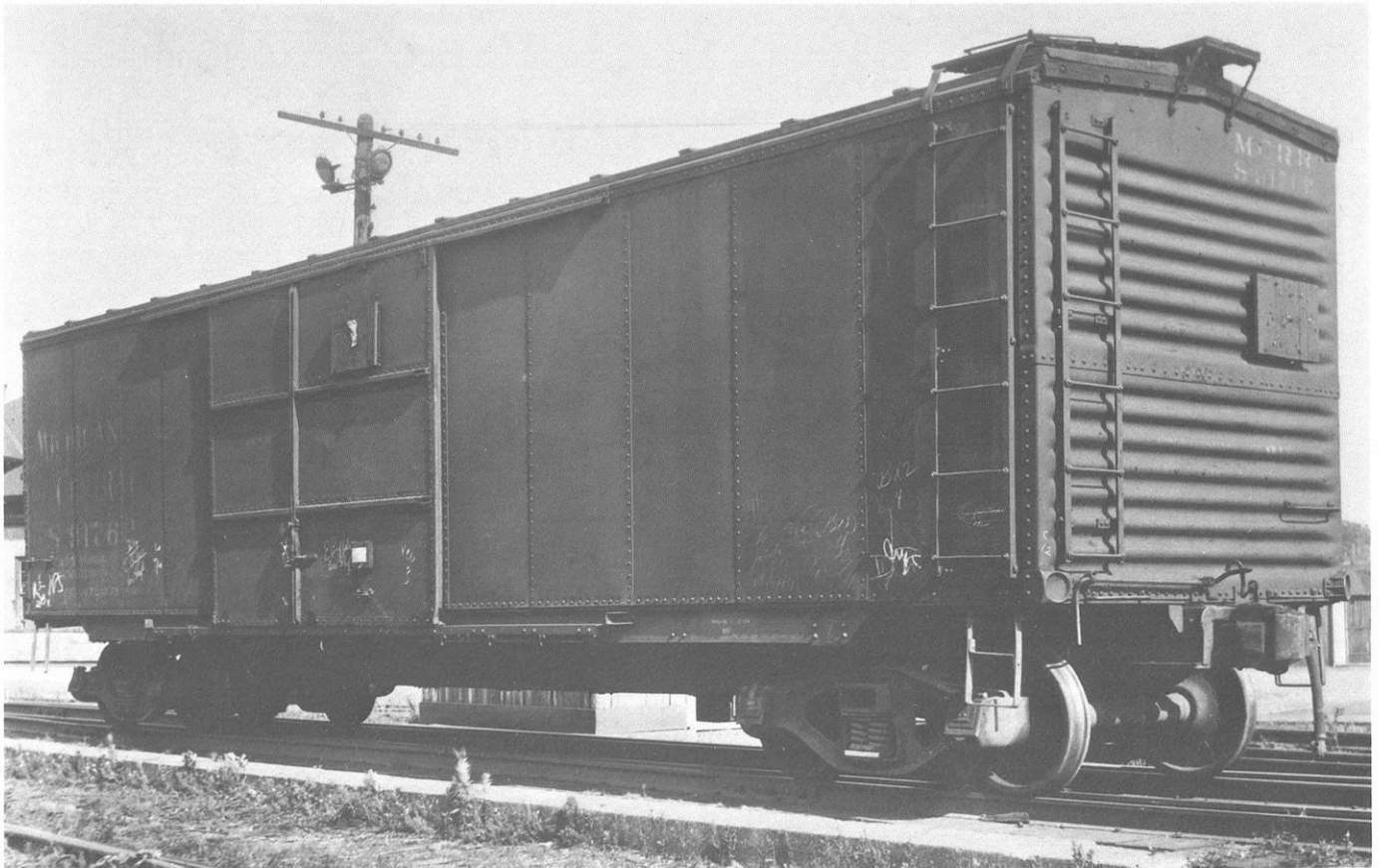

ABOVE - Michigan Central S-91762, Lot 337B was another of the H&B products of 1916. Other lots involved in the 1916 project were 330B (H&B 500 cars), 338B (ACF 1000 cars), 339B (Pullman, 1000 cars), 342B & 343B (ACF, 1000 and 500 cars respectively). Kent Singer Collection, courtesy of John LaRue Jr.

Below - New York Central S-260035, Lot 357B was built in 1917. The NYC's commitment to all-steel box and auto box cars was not complete even after the 6000 cars produced in 1916, many wood sheathed lots were produced, but in coming years, they would be converted to all-steel cars, often with increased capacities due to enlarged internal dimensions. Richard Burg Collection



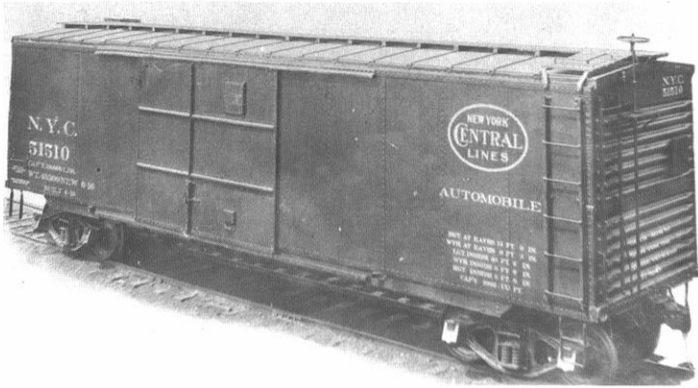

NYC 51510, Lot 341B was a typical example of the non-end door version of the 1916 NYC all-steel box car. Five hundred of these cars were built by Haskel & Barker in June of 1916.

Max Robin Collection, courtesy of Al Westerfield



NYC 134469, Lot 695B. This is a 1916 all-steel box car as rebuilt in 1941 with a single door and new roof.

Fred L. Huss Collection



Pennsylvania RR 563958, X25B was an experimental attempt to increase the headroom in the X25A, three such cars were rebuilt, plus a fourth X25C which tried to meet the same goal with a PRR round roof replacement. Government financing for large numbers of new roundroof box and auto box cars probably had something to do with the decision to not pursue this work. Richard Burg Collection



Seaboard 252827, a National Steel Car built 100-ton covered hopper recently acquired from the Warrenton RR. David G. Casdorff photo

Seaboard System has picked up quite a few used covered hoppers recently from the Warrenton Railroad. There are three series involved as follows:

SBD 252715-252806 ex- WAR 15000-15199 built by Pullman-Standard (lot 1068). Gray  
 SBD 252807-252912 ex- WAR 14000-14249 built by National Steel Car (see photo)  
 SBD 252913-253010 ex- WAR 16000-16099 built by Pullman-Standard (lot 1068). Blue.  
 -Carl W. Shaver

Union Pacific (incl. MP/WP) continues to purchase new auto racks at an alarming rate. Missouri Pacific MP initialed racks began deliveries in late 1985 with both bi-levels and tri-levels from Thrall Car and United American (Thrall Car) and Thrall's Winder, Georgia plant. So far, there has been 9-85 and 10-85 build dates for the MP bi-levels and only a 9-85 build date for the MP tri-levels reported so far.

Union Pacific initialed auto racks have also recently been delivered. These are numbered in the UP 7400's and are built by Thrall Car as tri-levels, Job 867. So far a 1-86 and 2-86 new built dates have been sighted.

All the above orders of MP/UP auto racks are mounted on TTGX (bi-level) and ETTX (tri-level) Trailer Train flatcars.  
 -David G. Casdorff

## SHORTLINE NEWS

Atlanta & Saint Andrews Bay RR recently acquired 100 used general-service boxcars from the Green Bay & Western 8200 series. The A&SAB RR assigned the series numbers ASAB 7300-7399. These cars were originally delivered to the Wabash Valley Railroad as series WVRC ,8100-8199. -Carl W. Shaver

Columbus & Greenville Rwy acquired forty 70-ton 50'9" boxcars with 12' sliding doors from the Ashley, Drew & Northern late last year. The C&G Rwy numbers are CAGY 9000-9039. They were originally built by SIECO in 1979 as general service box cars (XM) and came from the AD&N series ADN 9400-9699. The C&G Rwy changed the AAR designation to XP (special products box car)

In addition, the C&G Rwy has also placed in service 25 second-hand National Steel Car 100-ton covered hoppers from a presently unknown previous owner. The cars were built in 1979. The C&G Rwy retained the original numbers. These include various random numbers from 260449 to 260541. -David Casdorff

Escanaba & Lake Superior RR acquired 20 65'1" 1969 Greenville built gondolas from the Baltimore & Ohio series 364300-364399.  
 -Carl W. Shaver

Gulf & Mississippi RR has placed in their reporting marks a presently unknown number of cars from the Chicago Freight Car Leasing Co. 4801 series covered hoppers (sighted was GMSR 4806, ex CRDX 4806)  
 -Carl W. Shaver

Hartford and Slocomb RR recently placed in service ten ex East Camden and Highland 50'6" 1979 FMC built general-service boxcars. The H&S numbered them HS 70101-70110.  
 - Carl W. Shaver

Iowa Interstate just received fifty ACF Center-Flows from the Tuscola and Saginaw Bay Rwy. The cars were built in 1979 at ACF's Huntington plant. The T&SB numbers, 4901-4950, were not changed by the Iowa Interstate (thus, IAIS 4901-4950 are the "new" numbers).  
 -Carl W. Shaver

Indiana Hi-Rail Corp received 21 50'6" 70-ton 1979 Fruit Growers Express built general-service boxcars from the Apalachicola Northern early in 1985. Indiana Hi-Rail numbers are IHRC 11000-11020.  
 -David G. Casdorff

Jefferson Warrior RR is picking up used cars of various types. Their first series is a group of one-hundred 50'7" 70-ton single sliding-door 1979 CNCF (Mexico) built general-service boxcars from the Columbus and Greenville Rwy. Jefferson Warrior has numbered these JEFW 1000-1099.

The second series reported to FCJ is a group of 100-ton Pullman-Standard 1981 built rotary-end open hoppers numbered in the JEFW 2000's. Its presently not known where the Jefferson Warrior acquired these from. They are black with with rotary ends. -Carl Shaver / Pat Holden

Minnesota, Dakota & Western Rwy entered the piggyback van arena with several different series. One of these series is the group formerly lettered for the Boise Cascade Corp. (BCCZ) and built by Strick. The series is MDWZ 250600+.  
 -David G. Casdorff

North Shore RR Co. received twenty 50'7" 70-ton double-door 1978 Pacific Car & Foundry built general-service boxcars from WCTU Railway last year. The cars are from the series WCTR 101700-101899. The random 20 numbers acquired by the North Shore were not changed. -E.Neubauer

Vermont Railway placed in service a series of new 1985 Pines built 45-foot piggyback trailers (vans) with the series beginning with VTRZ 236426.  
 -David G. Casdorff

Waterloo Railroad series 503450-503549 are second-hand 50'7" 1979 CNCF built general-service boxcars that came from the Columbus and Greenville series 21500-21699. - Carl W. Shaver

## PRIVATE OWNERS & LESSEES NEWS

ADM Transportation's 18001 series of rebuilt "Uni-Temp" tank cars have now exceeded the number 18023 with latest rebuilt dates of 1-86. Apparently Rail-services Inc. of Calvert City, KY are the contractors doing the rebuilding. These 18,500 gallon tank cars are unique in the ADM fleet by having an interesting white with dark blue, medium blue and gold stripes. (See also FCJ 3:1 p.6)

ADMX 29451-29650 were delivered from its builder late last year. These are 30100 gallon 100 ton tank cars. So far only a 9-85 build date has been sighted - but there are sure to be later dates than this. Builder presently not known. - Carl W. Shaver / D.G. Casdorff

Air Products and Chemicals Inc. received fifty-four 21,500 gallon 100-ton insulated lined tank cars built by Trinity's Longview, TX plant in 4-85. These are numbered APRX 2121-2174.  
 -David G. Casdorff

Asarco Inc. transporters of sulfuric acid have picked up several new series of sulfuric acid tank cars that have not previously been reported to FCJ.

The first of these series is ASTX 2076-2140 (65 tank cars) built by ACF at Milton 9-12-83. These are 100-ton 13,600 gallon cars.

Next, Trinity built 100 tank cars for the series ASTX 3001-3100. These 13,600 gallon 100-ton tank cars have build dates from 11-83 to 12-83.

Lastly, (see photo next page) is series 2141-2210 (70 tankcars) built by ACF's Milton plant in 7-85. These two are 100-ton 13,600 gallon tank cars. - David G. Casdorff

Cargill Inc., received delivery of two new series of tank car recently.

Trinity's Longview plant finished the series CRGX 7000-7049 with a 6-85 build date (see also FCJ 3:1 p.6)

The latest series are 150 cars built by Union Tank Car of the series CRGX 7050-7199 vegetable oil tankers with build dates of 10-85=1-86.

-Carl W. Shaver / David G. Casdorff

Detroit Edison Co. acquired 610 new built aluminum rotary gondola cars from Greenville Steel Car last year for service between Montana and Superior, Wisc.  
 - Al Tuner

General American Transportation Corp. as you may recall no longer builds their own cars anymore, having Trinity Industries to do this continues to place new





Asarco's ASTX 2174 an ACF built sulphuric acid tank car. Livery is white with black lettering. David G. Casdorff photo



PMTZ 32014, a new "piggyback" trailer for transporting automobiles. Built by Stuart (builders of truck auto carriers). Shown at Industry, CA in January 1986. Ed Flaughner photo

cars in for-lease service. In this issue there have been several sightings of Hydrogen Peroxide tankers built and delivered. These tank cars have full center sills (characteristic of Hydrogen peroxide tankers) and black bottom, white top tank livery. They are constructed of aluminum and generally have approximately a 20,500 gallon capacity. Cars in the GATX 73740's (73747) and 73750's (73751) are leased by Interox America and were built 8=10-85 by Trinity. GATX 73760's (± 73761 is an example) are leased by FMC Corporation built in 10-1985 by Trinity.

-Carl Shaver / David G. Casdorff

General Electric Railcar Services Corp. continues to build the North American designed PD 4000 family of 100-ton covered hoppers. Proctor and Gamble picked up a lease on some new built cars of this type in the NAHX 390444 series (390449, 390452 examples) built in 4-85. - David G. Casdorff

Midwest Grain Products Inc. received 22 new 100-ton 30,100 gallon tank cars built by Trinity Industries in January 1985. These are series MWSX 29637-29658. - David G. Casdorff

John Neas Tank Lines has placed in service three new 10-85 built Trinity 100-ton tank cars in the series JNTX 1014 to 1016. - Carl W. Shaver

Pullman Leasing Co. series PLCX 24100 to 24199 (100 cars) were recently transferred from the AGRI Financial Services series ALEX 1710-1809. These cars were originally built by Pullman-Standard as part of lot 1158 in 11=12-80. The PLCX cars still have the old olive green livery from their former ALEX owners. -Carl W. Shaver

Trailer Train Co. has been quite active in new acquisitions and conversions recently. A new batch of RTTX (twin-45/triple-28) piggyback flats are being

converted mostly by the Cal-Pro, Mira Loma Shops. The new batch includes replacing of some hitched with the new fixed Trinity hitches. Conversion dates so far are 10-85=3-86.

DTTX prefixed Gunderson built double stack articulated container cars continue from 63175 and up. DTTX 63176 is a class GWG50C. DTTX 63180's and up are the new Santa Fe stacks. These later, Santa Fe stacks are classed GWG50D and have a build date of 3-1986 so far....The cars are standard TT yellow with large black Santa Fe circle-cross logo and "Econo-Stack" slogan. More on these later.

250 new single-van TTUX piggyback flat cars (like the Thrall Front-Runners) were delivered in 10=11-85 by Bethlehem Steel with numbers TTUX 135500-135749, class BLF-10.

In addition Bethlehem is converting some 2400 piggyback flat cars for auto rack service. - Ed Flaughner / Eric A. Neubauer / Al Tuner / David G. Casdorff